

Model 40/4, 60/4, (L)

Terminal Assignment

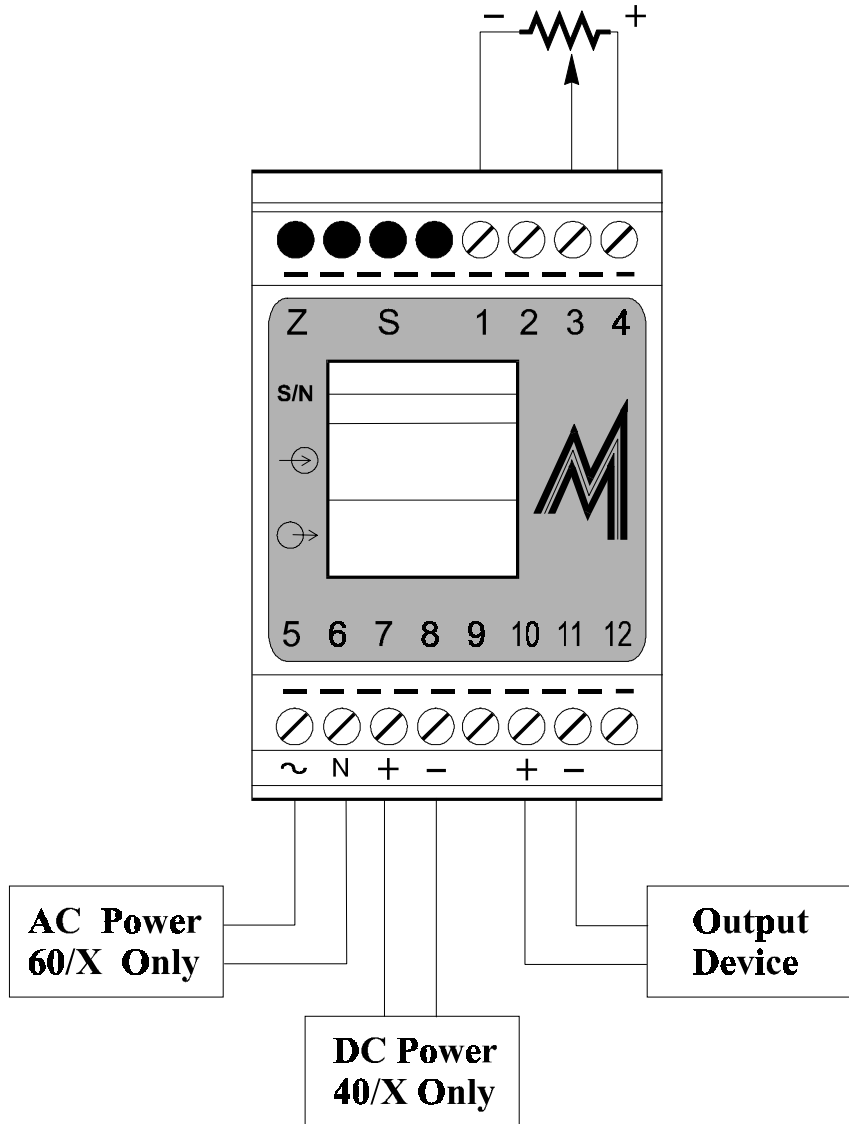

U.O.S ALL DIMENSIONS ARE IN mm
THE DOCUMENT AND ITS
CONTENTS ARE THE CONFIDENTIAL
PROPERTY OF MESCON AND SHALL
NOT BE REPRODUCED, DISCLOSED
TO OTHERS, OR USED AS THE
BASIS FOR THE MANUFACTURE
OR SALES OF APPARATUS OR
FOR ANY OTHER PURPOSE
WITHOUT THE WRITTEN PERMISSION
OF MESCON.



MESCON TECHNOLOGIES, LTD.

REV	DESCRIPTION	MEMO	DRAWN: SURPIN MARINA		DATA: 03.01.99
			CHECKED:		
			APPROVED: BOLURIAN ITZIK		DATA: 03.01.99
TITLE: Model 40/4, 60/4, (L) - wiring diagram					
DRAWING STATUS			DRAWING NUMBER		REV
_PRELIMINARY			SHEET OF SHEETS		
_ENGINEERING					
_PRODUCTION					